

ENVIRONMENTAL PRODUCT DECLARATION

TRADITIONAL CURTAIN WALL

ALUMINUM CURTAIN WALL SYSTEMS



Curtain walls define the modern commercial buildings with clean aesthetics, expansive views with virtually seamless walls of glass. Kawneer products are comprised of extrusions made from one of the earth's most plentiful recyclables — aluminum. Durable and lasting, the extruded products also boast aesthetically appealing design features that can help contribute to energy efficiency and long term sustainability.



Kawneer Company, Inc., part of Arconic's global Building and Construction Systems (BCS) business, has provided the commercial construction industry with best-in-class architectural aluminum products and service for more than 100 years. Its extensive range of solutions — from curtain walls and windows to entrances and framing systems — help build infinite possibilities for thermal performance, hurricane resistance, blast mitigation and sun control.

Kawneer's commitment to social and environmental responsibility is rooted in high performing, sustainable solutions that extend beyond energy efficiency to elements like daylighting, acoustical efficiency, recyclability, occupant security and occupant comfort. In fact, sustainability is at the heart of Kawneer's product line, which is comprised of one of the earth's most plentiful recyclables — aluminum.

Kawneer offers architects a new way to look at the building façade, placing endless design and sustainability options at their fingertips.

For more information visit
www.kawneer.com





ENVIRONMENTAL PRODUCT DECLARATION



According to ISO 14025, EN 15804
and ISO 21930:2017

Traditional Curtain Wall

EPD PROGRAM AND PROGRAM OPERATOR NAME, ADDRESS, LOGO, AND WEBSITE	UL ENVIRONMENT 333 PFINGSTEN ROAD NORTHBROOK, IL 60611	HTTPS://WWW.UL.COM HTTPS://SPOT.UL.COM
GENERAL PROGRAM INSTRUCTIONS AND VERSION NUMBER	General Program Instructions v.2.5 March 2020	
ASSOCIATION NAME AND ADDRESS	Kawneer North America 555 Guthridge Ct. Technology Park/Atlanta Norcross, GA 30092	
DECLARATION NUMBER	4789733794.108.1	
DECLARED PRODUCT & DECLARED UNIT	Traditional Curtain Wall, 1 m ²	
REFERENCE PCR AND VERSION NUMBER	Part A: Calculation Rules for the LCA and Requirements Project Report, (IBU/UL Environment, V3.2, 12.12.2018) (IBU/UL, 2018); and, Part B: Requirements on the EPD for Self supporting façade elements based on glazed curtain walls (IBU, V1.7, 04.01.2019) (IBU, 2019)	
DESCRIPTION OF PRODUCT APPLICATION/USE	Self-supporting façade element	
MARKETS OF APPLICABILITY	North America	
DATE OF ISSUE	October 1, 2021	
PERIOD OF VALIDITY	5 years	
EPD TYPE	Company specific	
EPD SCOPE	Cradle to gate	
YEAR(S) OF REPORTED PRIMARY DATA	2019	
LCA SOFTWARE & VERSION NUMBER	GaBi v10 (Sphera, 2020)	
LCI DATABASE(S) & VERSION NUMBER	GaBi 2021 (CUP 2021.1)	
LCIA METHODOLOGY & VERSION NUMBER	IPCC AR5 (GWP), CML-IA v4.8, (GaBi, 2021), TRACI 2.1 (Bare, 2012)	

The sub-category PCR review was conducted by:	Institut Bauen und Umwelt e.V.
	The Independent Expert Committee (SRV)
	info@ibu-epd.com
This declaration was independently verified in accordance with ISO 14025: 2006. The UL Environment "Part A: Calculation Rules for the Life Cycle Assessment and Requirements on the Project Report," v3.2 (December 2018), in conformance with ISO 21930:2017, serves as the core PCR, with additional considerations from the USGBC/UL Environment Part A Enhancement (2017) <input type="checkbox"/> INTERNAL <input checked="" type="checkbox"/> EXTERNAL	 James Mellentine, Thrive ESG
	Sphera  James Mellentine, Thrive ESG
This life cycle assessment was conducted in accordance with ISO 14044 and the reference PCR by:	Sphera
This life cycle assessment was independently verified in accordance with ISO 14044 and the reference PCR by:	 James Mellentine, Thrive ESG

LIMITATIONS

Exclusions: EPDs do not indicate that any environmental or social performance benchmarks are met, and there may be impacts that they do not encompass. LCAs do not typically address the site-specific environmental impacts of raw material extraction, nor are they meant to assess human health toxicity. EPDs can complement but cannot replace tools and certifications that are designed to address these impacts and/or set performance thresholds – e.g. Type 1 certifications, health assessments and declarations, environmental impact assessments, etc.

Accuracy of Results: EPDs regularly rely on estimations of impacts; the level of accuracy in estimation of effect differs for any particular product line and reported impact.

Comparability: EPDs from different programs may not be comparable. Full conformance with a PCR allows EPD comparability only when all stages of a life cycle have been considered. However, variations and deviations are possible". Example of variations: Different LCA software and background LCI datasets may lead to differences results for upstream or downstream of the life cycle stages declared.



ENVIRONMENTAL PRODUCT DECLARATION



Traditional Curtain Wall (CW)

According to ISO 14025, EN 15804,
and 21930:2017

Product Definition and Information

Description of Organization

Kawneer Company, Inc., part of Arconic's global Building and Construction Systems (BCS) business, has led the façade industry with innovative, high-performing building envelope solutions for more than a century. With locations across North America and Europe, Kawneer manufactures a broad range of architectural aluminum systems from curtain walls and entrances to framing systems and windows. Kawneer's technical expertise and product capability enhance building performance, protection and productivity to deliver inspiring buildings around the world. Part of Arconic Corporation's global Building and Construction Systems business, Kawneer innovation is advancing the frontiers of building and architectural design.

Product Description

Kawneer curtain wall systems are designed to minimize heat gain/loss (thermal conductance) through the curtain wall systems. Once viewed as an outer skin able to keep out water and hold glass, curtain wall systems have evolved into much more, offering not only high thermal performance, but also benefits such as blast mitigation, hurricane resistance and day lighting. Structural Silicone Glazed (SSG) curtain wall for low-to-mid-rise applications is designed to be used independently or as an integrated system, with 1600 Wall System™1, to provide visual impact for almost any type of building.

Traditional Curtain wall featuring:

- 1600 WALL SYSTEM™ 1, 1600 WALL SYSTEM™ 2, 1600 WALL SYSTEM™ 3, 1600 WALL SYSTEM™ 4, 1600 WALL SYSTEM™ 5
- 1600 SS CURTAIN WALL SYSTEM,
- 1600 UT SYSTEM™ 1 CURTAIN WALL, 1600 UT SYSTEM™ 2 CURTAIN WALL SYSTEM,
- 1620/1620 SSG CURTAIN WALL SYSTEM, 1620UT CURTAIN WALL SYSTEM,
- 1630 SS IR CURTAIN WALL SYSTEM,
- 2250 IG CURTAIN WALL SYSTEM,
- 2250 LR WALL SYSTEM,
- 7500 WALL™ CURTAIN WALL SYSTEM
- CLEARWALL CURTAIN WALL SYSTEM

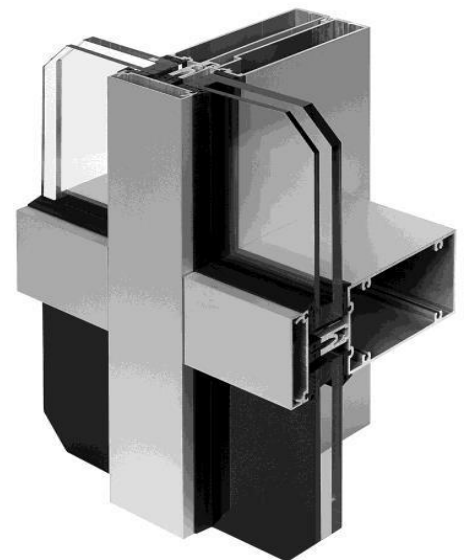

Figure 1 1630 SS IR CURTAIN WALL SYSTEM

The combination of aesthetics and thermal performance, curtain wall and glass manufacturers are working in concert to improve thermal efficiency. Many systems are able to integrate seamlessly with high-performing windows and doors, providing a complete façade solution that reduces energy demands and environmental impact. Thermal break technologies, as well as improved integrated sun control, are high on the list of options available in current systems.

For thermal performance, a product is considered thermally broken if the separation between the interior and exterior metal is 0.21 inches

ENVIRONMENTAL PRODUCT DECLARATION



Traditional Curtain Wall (CW)

According to ISO 14025, EN 15804,
and 21930:2017

or greater. Thermally improved systems are generally defined as having a separation between the interior and exterior metal of less than 0.21 inches but not less than 1/16 inch. Our 1600 wall Systems have a thermally broken design using an EPDM gasket to create the spacing based on the fenestration guidelines.

Technical Specification

Table 1 Technical specification

Name	Value	Unit
Thermal transmittance (U-factor) AAMA 1503.1, AAMA 507, and NFRC 100	0.15 – 0.45	Btu/hr. ft ² .°F
Solar Heat-Gain Coefficient (SHGC) NFRC 200	0.10 – 0.70	
Condensation Resistance Factor (CRFf) AAMA 1503.1	33 - 82	
Water Infiltration ASTM E 331 and AAMA 501.1	10 - 20	psf
Air Infiltration ASTM E283 at 6.24 psf	0.01 – 0.06	
Impact Resistance ASTM E1886/1996, Testing Application Standard 201/202/203	Level A - E	Cfmft ²

Delivery Status

Traditional curtain walls are ideal for low rise applications, 4 stories or less, no more than one splice per mullion (Kawneer, 2021).

Industry Standards

Kawneer products are tested, certified, and labeled for the following performance standards:

- AAMA/WDMA/CSA 101/IS2/A440-17 (NAFS-North American Fenestration Standard/Specification for windows, doors, and skylights) for the most current version
- ASTM E283-04(2012), Standard Test Method for Determining Rate of Air Leakage Through Exterior Windows, Curtain Walls, and Doors Under Specified Pressure Differences Across the Specimen
- ASTM E330/E330M-14, Standard Test Method for Structural Performance of Exterior Windows, Doors, Skylights and Curtain Walls by Uniform Static Air Pressure Difference
- ASTM E331-00(2016), Standard Test Method for Water Penetration of Exterior Windows, Skylights, Doors, and Curtain Walls by Uniform Static Air Pressure Difference
- ASTM E547-00(2016), Standard Test Method for Water Penetration of Exterior Windows, Skylights, Doors, and Curtain Walls by Cyclic Static Air Pressure Difference
- ASTM E2268-04(2016), Standard Test Method for Water Penetration of Exterior Windows, Skylights, and Doors by Rapid Pulsed Air Pressure Difference
- AAMA 1503, AAMA 507 and NFRC 100 Thermal Transmittance – U-Factors
- AAMA 1503, CSA A440.2 and NFRC 500 Condensation Resistance (CRF,I,CR)



ENVIRONMENTAL PRODUCT DECLARATION



Traditional Curtain Wall (CW)

According to ISO 14025, EN 15804,
and 21930:2017

- AAMA 507 and NFRC 200 Overall Solar Heat Gain Coefficient and Visible Transmittance (SHGC) & (VT)
- AAMA 501.4-09, Recommended Static Test Method for Evaluating Curtain Wall and Storefront Systems Subjected to Seismic and Wind Induced Inter-story Drifts.
- AAMA 501.5-07, Test Method for Thermal Cycling of Exterior Walls.
- AAMA 501.1-17, Standard Test Method for Water Penetration of Windows, Curtain Walls and Doors Using Dynamic Pressure

Base And Ancillary Materials

Traditional curtain walls are primarily made with thermally treated Aluminum extrusions and are installed offsite.

Table 2 Base and ancillary materials

Material	Mass (kg)	Mass (%)
Thermally treated Aluminum extrusions	6.40 - 7.66	18.71% - 21.61%
Glass	27.8	~ 80%

Manufacturing

Kawneer's plants produce surface-treated (anodized and painted) aluminum extrusions. After extrusion and surface treatment, thermal barriers comprised of polymers are added to the aluminum extrusions to improve thermal performance. The aluminum-polymer composite is then fabricated to the required dimensions and assembled into curtain walls with hardware. Note that one facility, Visalia, CA, does not have extrusion capabilities and sources extruded aluminum from internal and external suppliers. All plants produce traditional curtain walls but the products are assembled off-site.

Product Processing/ Installation

Installation is not included in this study.

Packaging

Kawneer products are primarily packaged using paper and plastic wrap and steel strap prior to shipping to installation sites.

Recycling and Disposal

Product recycling is not included in this study.

Environment and Health

Product manufacturing: Plant emissions to air/soil/water are monitored (if applicable) and comply with local laws.



ENVIRONMENTAL PRODUCT DECLARATION



Traditional Curtain Wall (CW)

According to ISO 14025, EN 15804,
and 21930:2017

Product use: Kawneer products are not expected to create exposure conditions that exceed safe thresholds for health impacts to humans or flora/fauna under normal operating conditions.

Life Cycle Assessment Background Information

Declared Unit

The declared unit of the underlying life cycle assessment study was one square meter (1 m²) of traditional curtain wall (including frame). The reference flow is 34.9 kg of product unit with framing, with a frame to glazing ration of 20% to 80% by mass. The 1.5m x 1.6m curtain wall standard size was used to derive the declared unit.

System Boundary

This study considers the cradle-to-gate life cycle (A1-A3) of aluminum window products. That is, it includes the potential environmental impacts associated with the extraction of resources from nature through to the point at which the finished product is ready to leave the fabricator's gate.

Transportation to the job site (A4), construction (A5), the use stage (B1-B7), the disposal stage (C1-C4), and benefits and loads beyond the system boundary (D) are excluded from the LCA and EPD scope. The product life cycle stages included within this boundary are illustrated in Figure 2.



ENVIRONMENTAL PRODUCT DECLARATION



Traditional Curtain Wall (CW)

According to ISO 14025, EN 15804, and 21930:2017

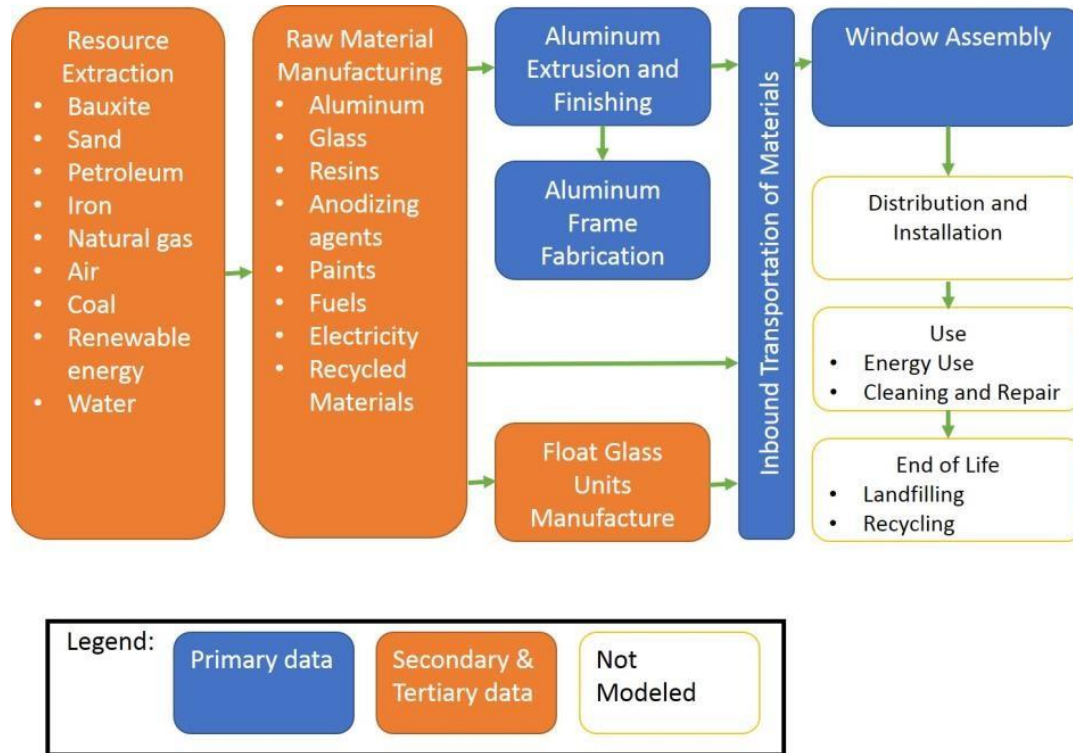

Figure 2. Life cycle stage diagram for cradle-to-gate production of traditional curtain wall

The life cycle stages (modules) are presented in the table below.

Table 3 System boundary modules included and excluded from the study, in accordance with EN 15804

DESCRIPTION OF THE SYSTEM BOUNDARY (X = INCLUDED IN LCA; MND = MODULE NOT DECLARED)																
PRODUCT STAGE			CONSTRUCTION PROCESS STAGE		USE STAGE							END OF LIFE STAGE				BENEFITS AND LOADS BEYOND THE SYSTEM BOUNDARIES
Raw material supply	Transport	Manufacturing	Transport	Construction-installation process	Use	Maintenance	Repair	Replacement ¹	Refurbishment ¹	Operational energy use	Operational water use	De-construction demolition	Transport	Waste processing	Disposal	Reuse-Recovery-Recycling-potential
A1	A2	A3	A4	A5	B1	B2	B3	B4	B5	B6	B7	C1	C2	C3	C4	D
X	X	X	MND	MND	MND	MND	MND	MND	MND	MND	MND	MND	MND	MND	MND	MND

* X = module included, MND = module not declared



ENVIRONMENTAL PRODUCT DECLARATION



Traditional Curtain Wall (CW)

According to ISO 14025, EN 15804,
and 21930:2017

Time coverage: Kawneer primary data represent production within the calendar year 2019. Background data for upstream and downstream processes (i.e., raw materials, energy resources, transportation, and ancillary materials) were obtained from the GaBi databases (CUP 2021.1).

Technology coverage: Data represent the production of aluminum extrusions at Kawneer's facilities in the United States and Canada. Primary data from Kawneer manufacturing facilities were collected and used to describe the production of aluminum extruded framing material, surface treatment, and the assembly of windows system.

As required by the PCR, over 80% of the window material by mass are represented by primary data.

Geographical coverage: Kawneer manufactures aluminum window products at four US facilities and one Canadian facility. As such, the geographical coverage for this study is based on North American system boundaries for all processes and products. Whenever US/Canadian background data were not readily available, European data or global data were used as proxies.

Estimations and Assumptions

The manufacturing processes and end product are essentially the same at all manufacturing sites. Impacts and inventories for traditional curtain wall were calculated with a mass-based production-weighted average of each site's impacts and inventories.

Float glass is insulated, laminated, or tempered and added to the finished assembly. At this time, data does not include granularity to differentiate between insulated, laminated and tempered glass. As such, all glass is modeled the same.

Glass is only processed at the Cranberry facility. The remaining facilities produce and sell only the aluminum frames. For these facilities, the glass produced at the Cranberry facility was used as a proxy for the window glazing.

No significant assumptions have been made beyond the aforementioned. All of the raw materials and energy inputs have been modeled using processes and flows that closely follow actual production raw materials and processes. All of the material and energy flows have been accounted.

Cut-off Criteria

In the case of data gaps for unit processes, the cut-off criteria as defined by ISO 21930 were applied. All available energy and material flow data have been included in the model. In cases where no matching life cycle inventories are available to represent a flow, proxy data have been applied based on conservative assumptions regarding environmental impacts.

Data Sources

To ensure reliable results, first-hand industry data were used in combination with consistent background LCA information from the GaBi database (CUP 2021.1). The data for aluminum billet, as well as externally sourced aluminum extrusions, are based on Aluminum Association studies and are the best available. Other LCI datasets were sourced from the GaBi databases and are representative of the years 2018-2020.

Data Quality

In order to model cradle-to-gate life cycle of traditional curtain walls, the GaBi Professional software system (v10.5) developed by Sphera, Inc. was used. All relevant background data necessary for product modeling were taken from the GaBi databases (CUP 2021.1).

Inventory data quality is judged by its precision (measured, calculated or estimated), completeness (e.g., unreported emissions), consistency (degree of uniformity of the methodology applied on a study serving as a data source) and representativeness (geographical, temporal, and



ENVIRONMENTAL PRODUCT DECLARATION



Traditional Curtain Wall (CW)

According to ISO 14025, EN 15804,
and 21930:2017

technological).

To ensure reliable results, first-hand industry data were used in combination with consistent background LCA information from the GaBi databases. The data for aluminum billet, as well as externally sourced aluminum extrusions, are based on Aluminum Association studies and are the best available. Other LCI datasets were sourced from the GaBi databases.

LCI datasets from the GaBi LCI database are widely distributed and used with the GaBi Professional Software. The datasets have been used in LCA models worldwide in industrial and scientific applications in internal as well as in many critically reviewed and published studies. In the process of providing these datasets, they are cross-checked with other databases and values from industry and science.

Allocation

No multi-output (i.e., co-product) allocation was performed in the foreground of this study. Allocation of background data (energy and materials) taken from the GaBi 2021 databases is documented online at <https://sphaera.com/wp-content/uploads/2020/04/Modeling-Principles-GaBi-Databases-2021.pdf>.

Per the PCR guidance, recycling and recycled content in the cradle-to-gate system are modeled using the cut-off rule (a.k.a, the recycled content rule). All materials that are recycled from unit processes are considered to have left the system boundary. Recycled content is modeled in the system only when the percent of recycled content was specified in the material purchase.



ENVIRONMENTAL PRODUCT DECLARATION



Traditional Curtain Wall (CW)

According to ISO 14025, EN 15804,
and 21930:2017

Life Cycle Assessment - Results

Results given per declared unit of product.

Table 4 Cradle-to-gate (manufacturing, glazing, and frame) LCIA results of Kawneer Traditional Curtain Wall

Impact Category	Unit	A1 - A3	Frame	Glazing
LIFE CYCLE IMPACTS ASSESSMENT (LCIA) RESULTS				
<i>IPCC, AR5 (IPCC, 2013)</i>				
Global Warming Potential	kg CO ₂ eq.	1.36E+02	5.31E+01	8.32E+01
<i>CML-IA v4.8</i>				
Abiotic Depletion (ADP elements)	kg Sb eq.	1.74E-04	5.35E-05	1.20E-04
Abiotic Depletion (ADP fossil)	MJ	1.66E+03	6.57E+02	1.00E+03
Acidification Potential (AP)	kg SO ₂ eq.	6.74E-01	2.73E-01	4.01E-01
Eutrophication Potential (EP)	kg (PO ₄) ³⁻ eq.	6.26E-02	1.88E-02	4.38E-02
Ozone Layer Depletion Potential (ODP, steady state)	kg R11 eq.	2.21E-09	2.21E-09	1.90E-13
Photochem. Ozone Creation Potential (POCP)	kg C ₂ H ₄ eq.	-1.89E-02	1.97E-02	-3.86E-02
<i>TRACI 2.1</i>				
Acidification Potential (AP)	kg SO ₂ eq.	6.94E-01	2.67E-01	4.27E-01
Eutrophication Potential (EP)	kg N eq.	2.88E-02	7.68E-03	2.12E-02
Ozone Depletion (ODP)	kg CFC 11 eq.	2.35E-09	2.35E-09	1.90E-13
Resources, Fossil fuels (FF)	MJ surplus energy	1.63E+02	6.57E+01	9.71E+01
Smog Formation Potential (SFP)	kg O ₃ eq.	8.59E+00	3.27E+00	5.32E+00
RESOURCE USE INDICATORS				
Renewable primary resources used as energy carrier (fuel) (RPRE)	MJ	3.04E+02	2.18E+02	8.55E+01
Renewable primary resources with energy content used as material (RPR _M)	MJ	1.11E+00	1.11E+00	0.00E+00
Non-renewable primary resources used as an energy carrier (fuel) (NRPRE)	MJ	1.89E+03	6.44E+02	1.20E+03
Non-renewable primary resources with energy content used as material (NRPRM)	MJ	2.75E+00	2.24E+00	5.05E-01
Renewable secondary fuels (RSF)	MJ	--	--	--
Non-renewable secondary fuels (NRSF)	MJ	--	--	--
Recovered energy (RE)	MJ	--	--	--
Secondary material (SM)	kg	8.39E-02	8.39E-02	0.00E+00
Use of net fresh water resources (FW)	m ³	1.14E+00	9.17E-01	2.21E-01
OUTPUT FLOWS & WASTE FLOWS				
Hazardous waste disposed (HWD)	kg	2.03E-02	2.03E-02	9.18E-08
Non-hazardous waste disposed (NHWD)	kg	2.84E+00	2.33E+00	5.10E-01



ENVIRONMENTAL PRODUCT DECLARATION



Traditional Curtain Wall (CW)

According to ISO 14025, EN 15804, and 21930:2017

Impact Category	Unit	A1 - A3	Frame	Glazing
High-level radioactive waste, conditioned, to final repository (HLRW)	kg	1.04E-04	1.21E-05	9.21E-05
Intermediate- and low-level radioactive waste, conditioned, to final repository (ILLRW)	kg	9.04E-02	9.80E-03	8.06E-02
Components for reuse (CRU)	kg	--	--	--
Materials for Recycling (MFR)	kg	2.94E+00	2.94E+00	0.00E+00
Materials for Energy Recovery (MER)	kg	--	--	--
Exported Electrical Energy (EEE)	kg	--	--	--
Exported Thermal Energy (EET)	kg	--	--	--

Life Cycle Assessment - Interpretation

Results represent the cradle to gate environmental impacts of traditional curtain walls. Breakdowns of frame and glazing impacts are shown in Figure 3 representing TRACI 2.1 (Bare, 2012) impact categories and IPCC AR5 for GWP. Glazing component is contributing significantly in all impact categories except ODP. Float glass material and energy use during the glass processing drive the impacts for this component. Frame impacts, on the other hand, are mostly driven by use of primary alloys – including aluminum and steel. Use of secondary aluminum in extrusion processes can reduce overall impacts significantly. Assembly, extrusion and thermal processing are the top three impactful processes mainly due to resource use during these steps.

While similar processes show variations in resource use and waste across manufacturing locations, average results are affected by production volumes rather than process variations.

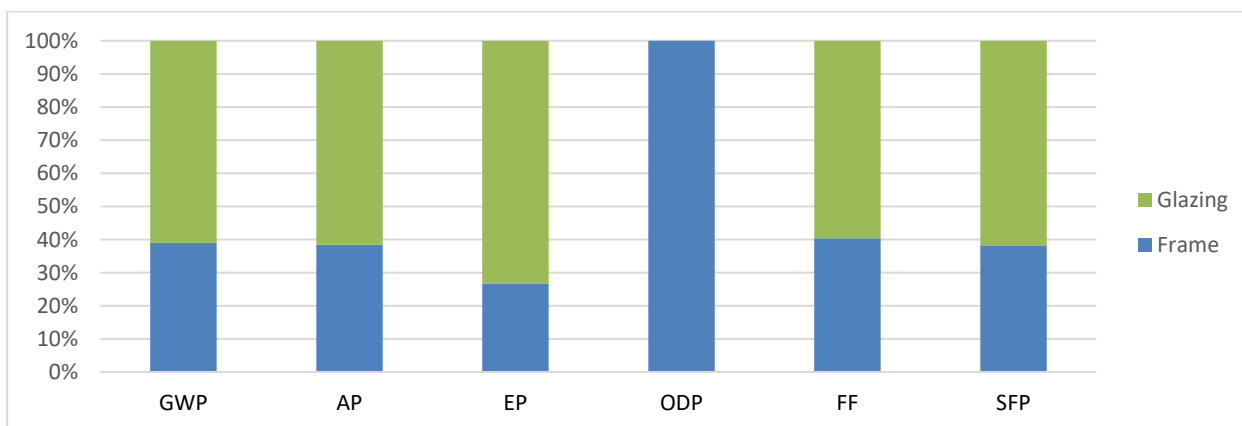

Figure 3. Contribution of frame and glazing in life cycle environmental impacts of traditional curtain wall

(GWP = Global warming potential (IPCC); AP = Acidification potential; EP = Eutrophication potential; ODP = Stratospheric ozone layer depletion potential; FF = Resources, Fossil fuels; SFP = Smog formation potential)



ENVIRONMENTAL PRODUCT DECLARATION



Traditional Curtain Wall (CW)

According to ISO 14025, EN 15804, and 21930:2017

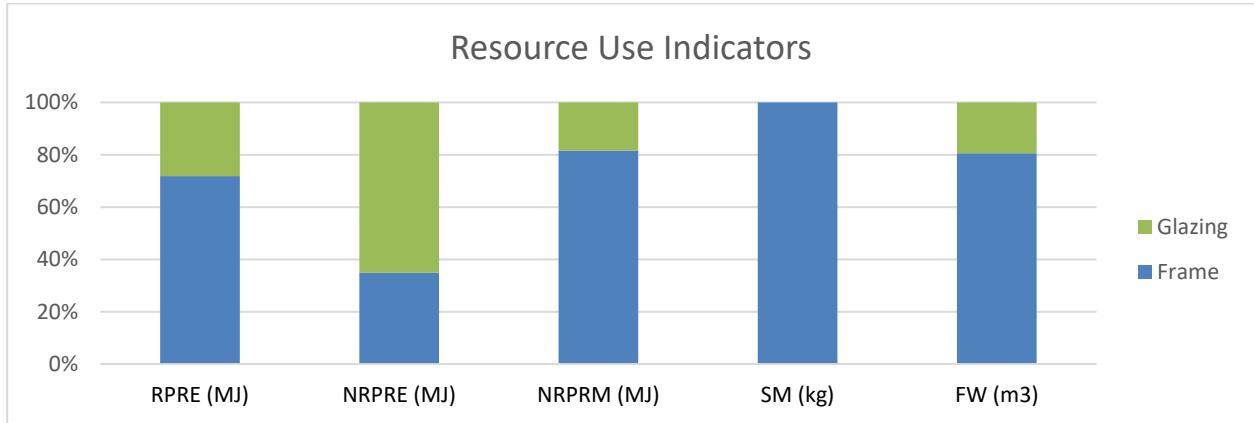

Figure 4. Traditional curtain wall resource use indicators (zero values are not shown in the graph)

(RPRE = Renewable primary resources used as energy carrier; NRPRE = Non-renewable primary resources used as an energy carrier; NRPRM = Non-renewable primary resources with energy content used as material; SM = Secondary material; FM = Use of net freshwater resources)

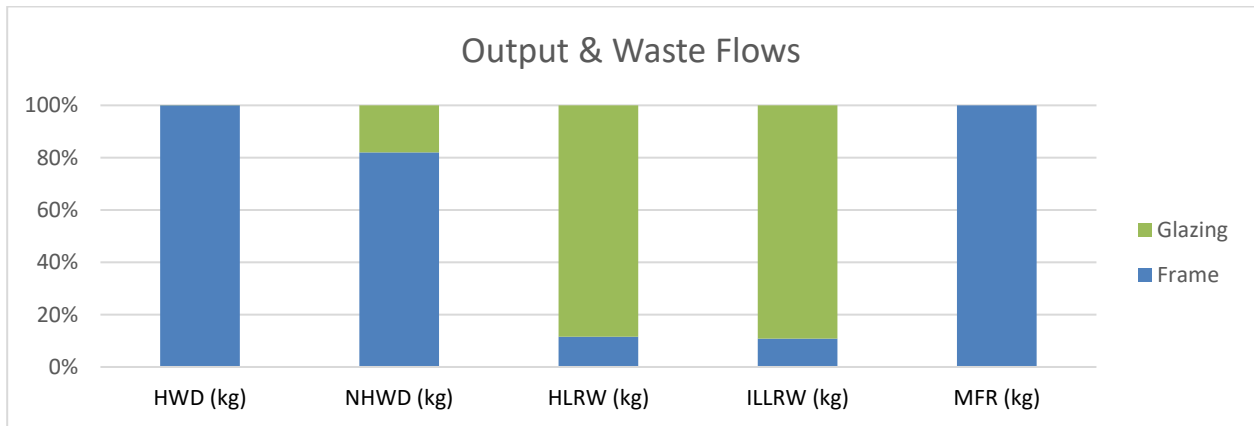

Figure 5. Traditional curtain wall output and waste flows (zero values are not shown in the graph)

(HWD = Hazardous waste disposed; NHWD = Non-hazardous waste disposed; HLRW = High-level radioactive waste; ILLRW = Intermediate- and low-level radioactive waste; MFR = Materials for Recycling)

Additional Information

Disclosure of Windows Hazardous Content

There are no materials present in at least 0.1% of the traditional curtain wall that are known to be hazardous to human health and the environment nor on the Candidate List Substances of Very High Concern (EPA, 2021).

Recyclable Content



ENVIRONMENTAL PRODUCT DECLARATION



Traditional Curtain Wall (CW)

According to ISO 14025, EN 15804,
and 21930:2017

Aluminum is a highly efficient sustainable building material. Aluminum is 100% recyclable and can be recycled repeatedly. The performance of recycled aluminum is identical to the one of smelted aluminum but requires only 1/20 of the energy to manufacture. In building and construction aluminum scrap has a recycling rate of 95% (UNEP, 2011) (EAA, 2021). The remaining 5% is sent to landfill.

Bibliography

- AAC. (2021). Retrieved from Aluminum Anodizers Council (AAC): <https://www.anodizing.org/page/what-is-anodizing>
- Bare, J. (2012). *Tool for the Reduction and Assessment of Chemical and other Environmental Impacts (TRACI) - Software Name and Version Number: TRACI version 2.1 - User's Manual*. Washington, D.C.: U.S. EPA.
- EAA. (2021). <https://www.european-aluminium.eu/>. Retrieved from European Aluminum Website.
- EPA. (2021). Retrieved from <https://www.epa.gov/environmental-topics/chemicals-and-toxics-topics>
- GaBi. (2021). Retrieved from <https://gabi.sphera.com/support/gabi/gabi-lcia-documentation/cml-2001/>
- .
- IBU. (2019). *Part B: Requirements on the EPD for Self supporting façade elements based on glazed curtain walls (IBU, V1.7, 04.01.2019)* .
- IBU/UL. (2014). *PCR Guidance-Texts for Building-Related Products and Services: Part B: Requirements on the EPD for Products of aluminium and aluminium alloys*. Berlin. IBU/UL.
- IBU/UL. (2018). *Part A: Calculation Rules for the LCA and Requirements Project Report*.
- Kawneer. (2021). Retrieved from https://www.kawneer.com/kawneer/north_america/catalog/97911/ADMD070EN.pdf
- Sphera. (2020). *GaBi LCA Database Documentation*. Retrieved from Sphera Solutions, Inc.: <http://www.gabi-software.com/america/support/gabi/>.
- Sphera. (2021). Retrieved from GaBi LCA Database Documentation: <http://www.gabi-software.com/america/support/gabi/>
- UNEP. (2011). *Recycling Rates of Metals : A Status Report*. Retrieved from UNE Document Repository: https://wedocs.unep.org/bitstream/handle/20.500.11822/8702/Recycling_Metals.pdf?sequence=1&isAllowed=y
- Worldsteel. (2017). Retrieved from https://www.worldsteel.org/en/dam/jcr:6eefabf4-f562-4868-b919-f232280fd8b9/LCI%2520methodology%2520report_2017.pdf

