

① PRESENTATION 1

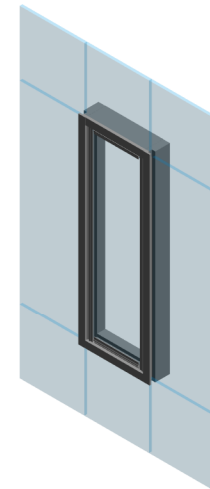

② PRESENTATION 2

KAWNEER AN ARCONIC COMPANY

555 Guthridge Ct.
Technology Park/Atlanta
Norcross, GA 30092 USA
Tel: +1 770 449 5555

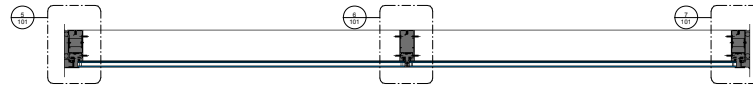

① BASIC WALL EXAMPLE
1 1/2" x 1'-0"



② SECTION
1 1/2" x 1'-0"

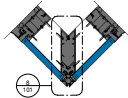

③ SGT 60° OUTSIDE CORNER
1 1/2" x 1'-0"

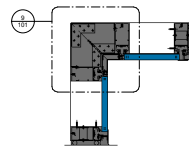

④ SGT 90° INSIDE CORNER
1 1/2" x 1'-0"

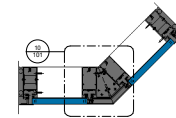

⑤ SGT 120° OUTSIDE CORNER
1 1/2" x 1'-0"

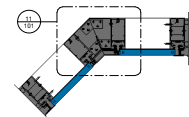

⑥ SGT 135° INSIDE CORNER
1 1/2" x 1'-0"

KAWNEER AN ARCONIC COMPANY

555 Guthridge Ct.
Technology Park/Atlanta
Norcross, GA 30092 USA
Tel: +1 770 449 5555

Kawneer

2500 UT SGT UNITWALL® SYSTEM 6-1/2" Deep / 7-1/2" Deep Captured (1" infill) - Typical 4-Side SGT Details

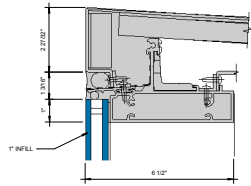

① SGT HEAD - 1" INFILL
6" = 1'-0"

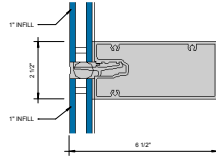

② SGT HORIZONTAL - 1" INFILL
6" = 1'-0"

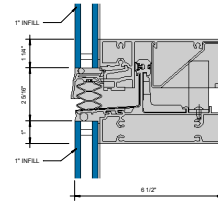

③ SGT EXPANSION HORIZONTAL - 1" INFILL
6" = 1'-0"

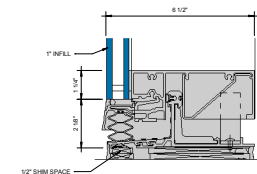

④ SGT SILL - 1" INFILL
6" = 1'-0"

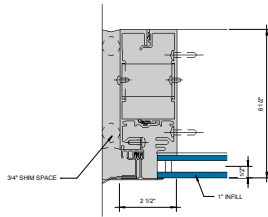

⑤ SGT JAMB - 1" INFILL
6" = 1'-0"

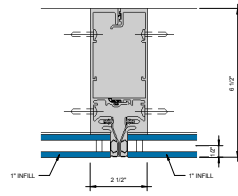

⑥ SGT VERTICAL MULLION - 1" INFILL
6" = 1'-0"

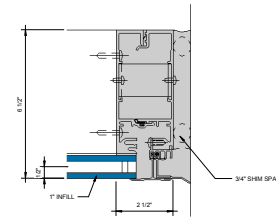

⑦ SGT JAMB - 1" INFILL
6" = 1'-0"

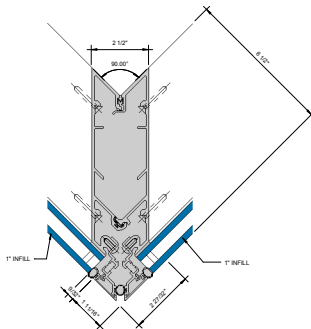

⑧ SGT 90° OUTSIDE CORNER - 1" INFILL
6" = 1'-0"

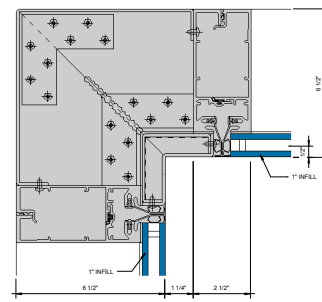

⑨ SGT 90° INSIDE CORNER - 1" INFILL
6" = 1'-0"

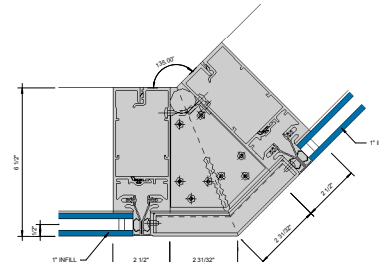

⑩ SGT 135° OUTSIDE CORNER - 1" INFILL
6" = 1'-0"

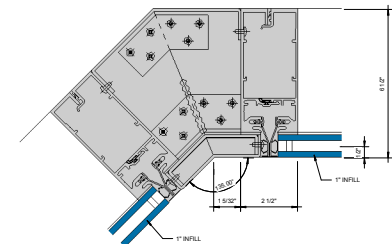

⑪ SGT 135° INSIDE CORNER - 1" INFILL
6" = 1'-0"

KAWNEER AN ARCONIC COMPANY

555 Guthridge Ct.
Technology Park/Atlanta
Norcross, GA 30092 USA
Tel: +1 770 449 5555



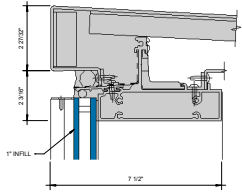

① HEAD - 1" INFILL
6" = 1'-0"

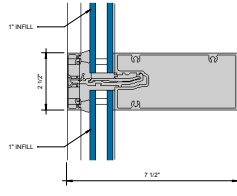

② HORIZONTAL - 1" INFILL
6" = 1'-0"

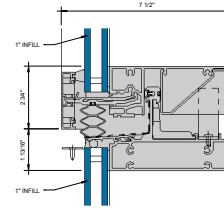

③ EXPANSION HORIZONTAL - 1" INFILL
6" = 1'-0"

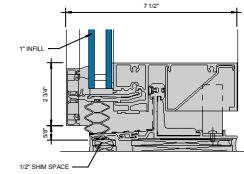

④ SILL - 1" INFILL
6" = 1'-0"

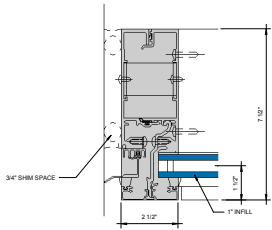

⑤ JAMB - 1" INFILL
6" = 1'-0"

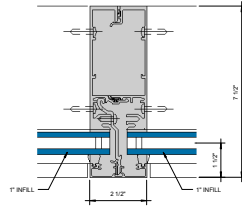

⑥ VERTICAL MULLION - 1" INFILL
6" = 1'-0"

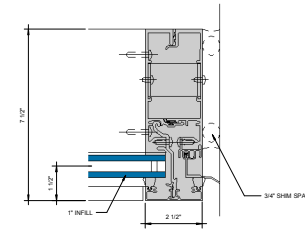

⑦ JAMB - 1" INFILL
6" = 1'-0"

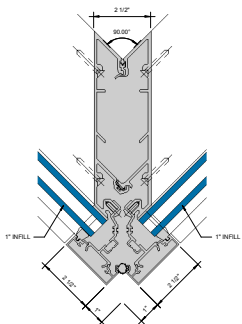

⑧ 90° OUTSIDE CORNER - 1" INFILL
6" = 1'-0"

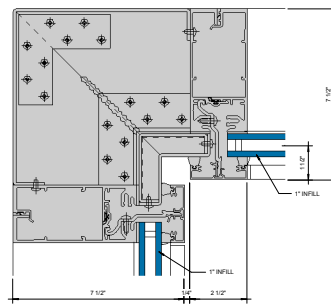

⑨ 90° INSIDE CORNER - 1" INFILL
6" = 1'-0"

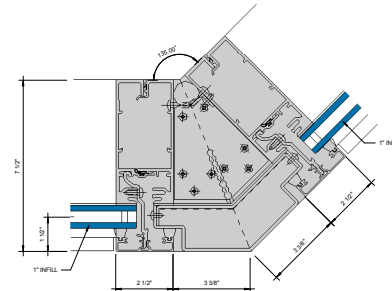

⑩ 135° OUTSIDE CORNER - 1" INFILL
6" = 1'-0"

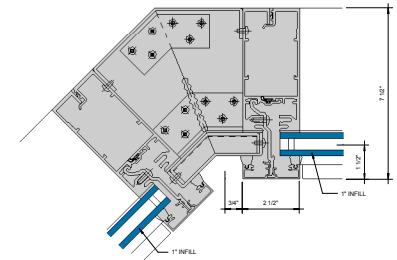

⑪ 135° INSIDE CORNER - 1" INFILL
6" = 1'-0"

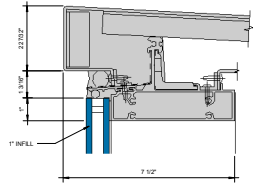

① SGT HEAD - 1" INFILL
6" x 1'-0"

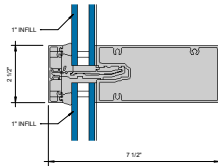

② HORIZONTAL - 1" INFILL
6" x 1'-0"

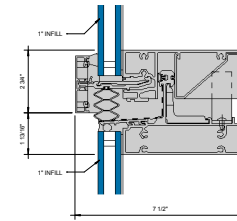

③ EXPANSION HORIZONTAL - 1" INFILL
6" x 1'-0"

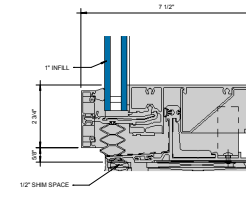

④ SILL - 1" INFILL
6" x 1'-0"

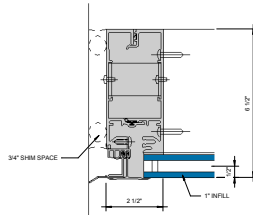

⑤ SGT JAMB - 1" INFILL
6" x 1'-0"

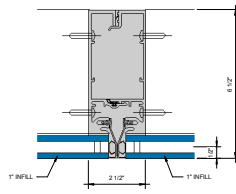

⑥ SGT VERTICAL MULLION - 1" INFILL
6" x 1'-0"

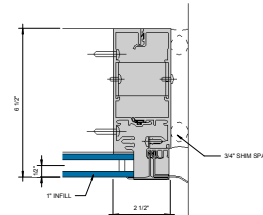

⑦ SGT JAMB - 1" INFILL
6" x 1'-0"

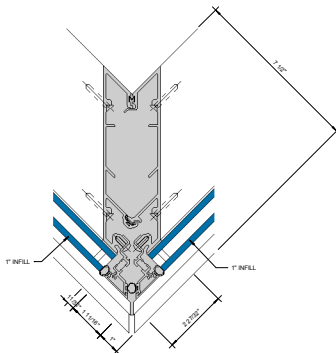

⑧ 90° OUTSIDE CORNER - 1" INFILL
6" x 1'-0"

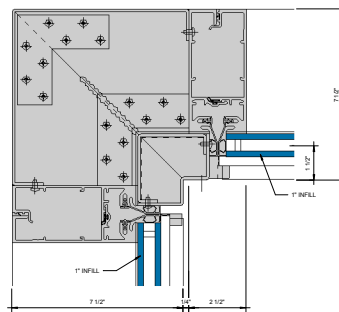

⑨ 90° INSIDE CORNER - 1" INFILL
6" x 1'-0"

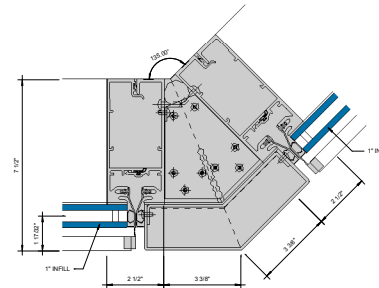

⑩ 135° OUTSIDE CORNER - 1" INFILL
6" x 1'-0"

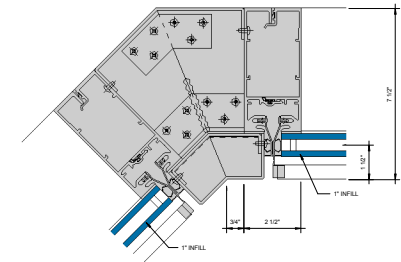

⑪ 135° INSIDE CORNER - 1" INFILL
6" x 1'-0"

Kawneer

2500 UT SGT UNITWALL® SYSTEM 6-1/2" Deep / 7-1/2" Deep Captured (1" infill) -GLASSvent® UT Window Details (4-side Captured Only) Steel Reinforcing and Anchor Details

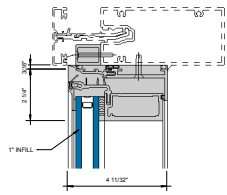

① HEAD PO- 1" INFILL
6" = 1"

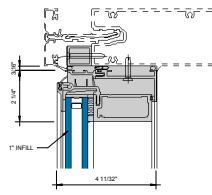

② HEAD COS- 1" INFILL
6" = 1"

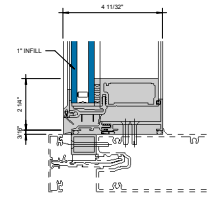

③ SILL- 1" INFILL
6" = 1"

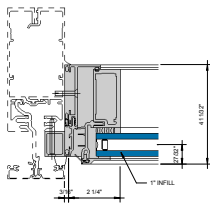

④ LEFT JAMB PO- 1" INFILL
6" = 1"

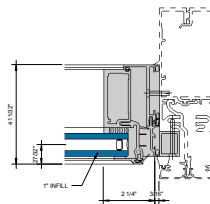

⑤ RIGHT JAMB PO- 1" INFILL
6" = 1"

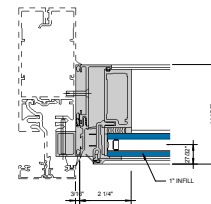

⑥ LEFT JAMB COS- 1" INFILL
6" = 1"

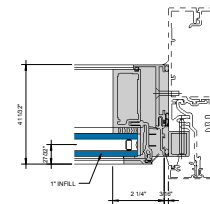

⑦ RIGHT JAMB COS- 1" INFILL
6" = 1"

KAWNEER AN ARCONIC COMPANY

555 Guthridge Ct.
Technology Park/Atlanta
Norcross, GA 30092 USA
Tel: +1 770 449 5555

KAWNEER
AN ARCONIC COMPANY

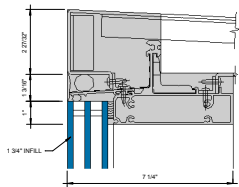

① SGT HEAD - 1-3/4" INFILL
Ø = 1'-0"

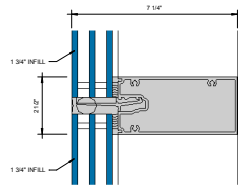

② SGT HORIZONTAL - 1-3/4" INFILL
Ø = 1'-0"

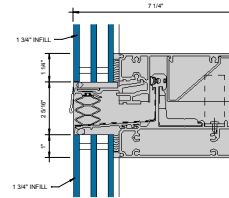

SGT EXPANSION HORIZONTAL - 1-3/4" INFILL
Ø = 1'-0"

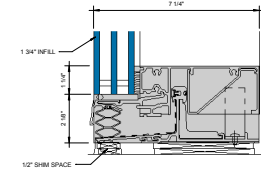

④ SGT SLL - 1-3/4" INFILL
Ø = 1'-0"

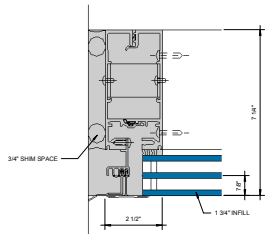

⑤ SGT JAMB - 1-3/4" INFILL
Ø = 1'-0"

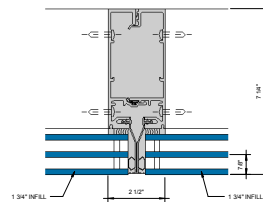

⑥ SGT VERTICAL MULLION - 1-3/4" INFILL
Ø = 1'-0"

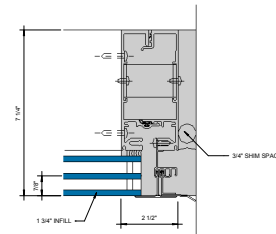

⑦ SGT JAMB - 1-3/4" INFILL
Ø = 1'-0"

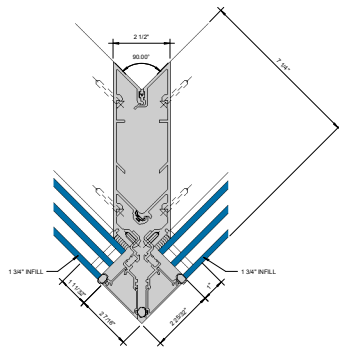

⑧ SGT 90° OUTSIDE CORNER - 1-3/4" INFILL
Ø = 1'-0"

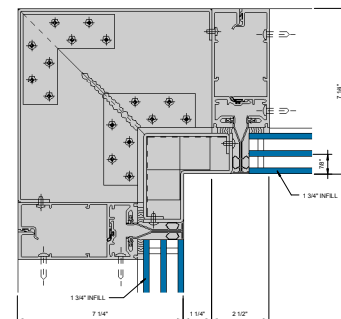

⑨ SGT 90° INSIDE CORNER - 1-3/4" INFILL
Ø = 1'-0"

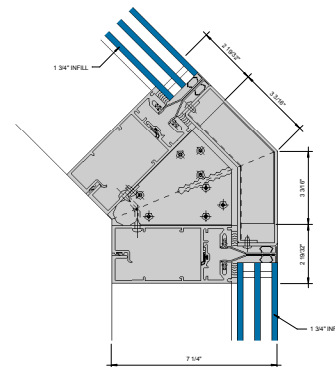

⑩ SGT 135° OUTSIDE CORNER - 1-3/4" INFILL
Ø = 1'-0"

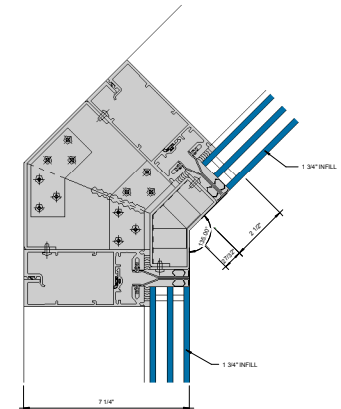

⑪ SGT 135° INSIDE CORNER - 1-3/4" INFILL
Ø = 1'-0"

KAWNEER AN ARCONIC COMPANY

555 Guthridge Ct.
Technology Park/Atlanta
Norcross, GA 30092 USA
Tel: +1 770 449 5555

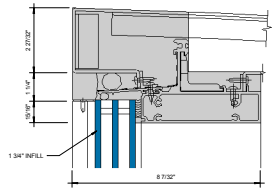

① HEAD - 1-3/4" INFILL
6" = 1'-0"

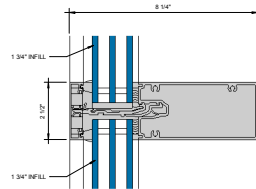

② HORIZONTAL - 1-3/4" INFILL
6" = 1'-0"

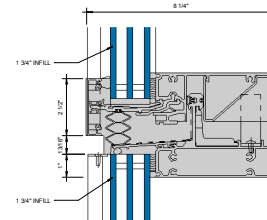

③ EXPANSION HORIZONTAL - 1-3/4" INFILL
6" = 1'-0"

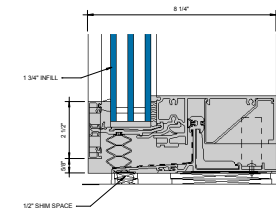

④ SILL - 1-3/4" INFILL
6" = 1'-0"

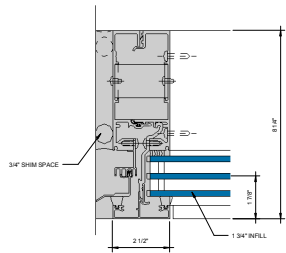

⑤ JAMB - 1-3/4" INFILL
6" = 1'-0"

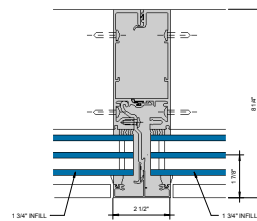

⑥ VERTICAL MULLION - 1-3/4" INFILL
6" = 1'-0"

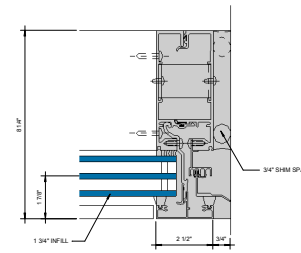

⑦ JAMB - 1-3/4" INFILL
6" = 1'-0"

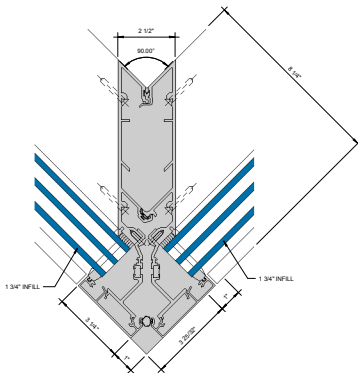

⑧ 90° OUTSIDE CORNER - 1-3/4" INFILL
6" = 1'-0"

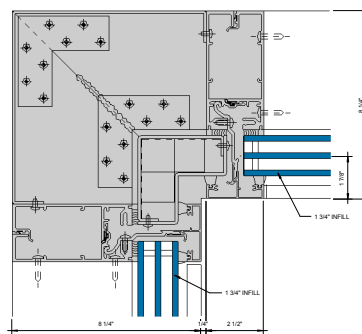

⑨ 90° INSIDE CORNER - 1-3/4" INFILL
6" = 1'-0"

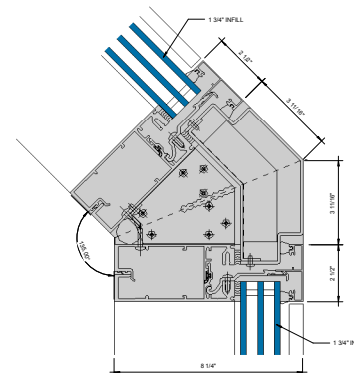

⑩ 135° OUTSIDE CORNER - 1-3/4" INFILL
6" = 1'-0"

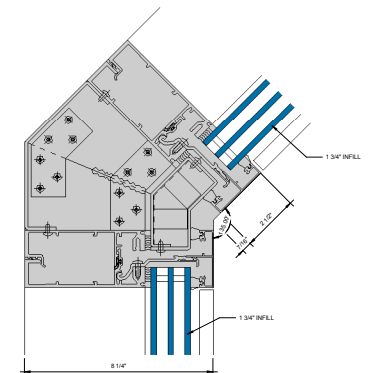

⑪ 135° INSIDE CORNER - 1-3/4" INFILL
6" = 1'-0"

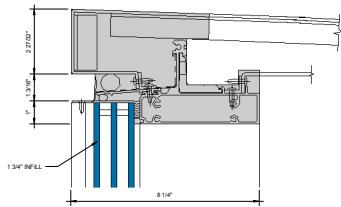

① HEAD - 1-3/4" INFILL
6" = 1'-0"

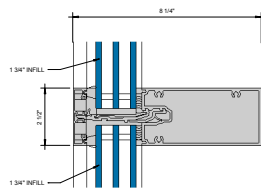

② HORIZONTAL - 1-3/4" INFILL
6" = 1'-0"

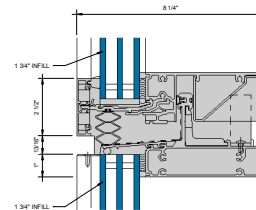

③ EXPANSION HORIZONTAL - 1-3/4" INFILL
6" = 1'-0"

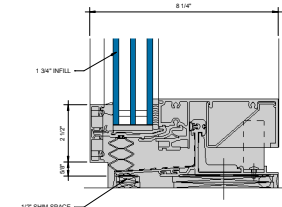

④ SILL - 1-3/4" INFILL
6" = 1'-0"

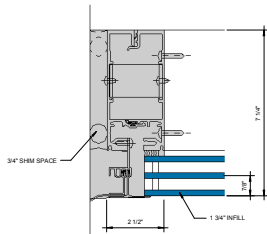

⑤ SGT JAMB - 1-3/4" INFILL
6" = 1'-0"

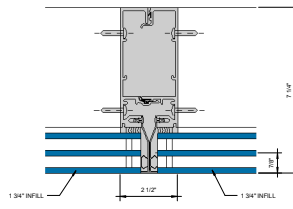

⑥ SGT VERTICAL MULLION - 1-3/4" INFILL
6" = 1'-0"

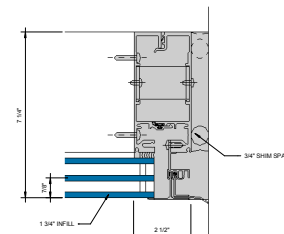

⑦ SGT JAMB - 1-3/4" INFILL
6" = 1'-0"

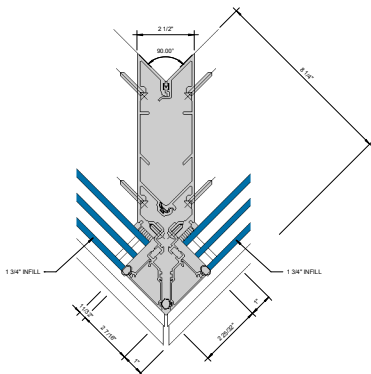

⑧ 90° OUTSIDE CORNER - 1-3/4" INFILL
6" = 1'-0"

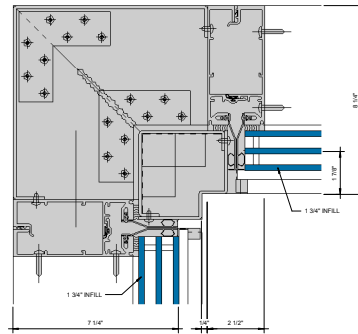

⑨ SGT 90° INSIDE CORNER - 1-3/4" INFILL
6" = 1'-0"

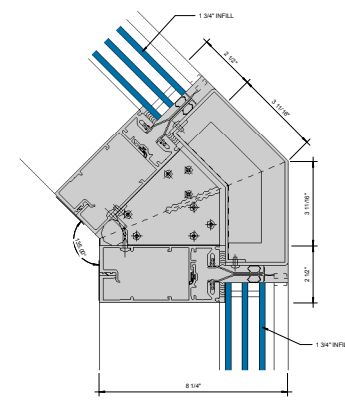

⑩ 135° OUTSIDE CORNER - 1-3/4" INFILL
6" = 1'-0"

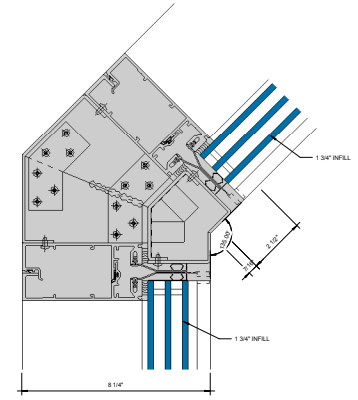

⑪ 135° INSIDE CORNER - 1-3/4" INFILL
6" = 1'-0"

2500 UT UNITWALL® SYSTEM 6-1/2" Deep SSG / 7-1/2" Deep Captured (1-3/4" infill) - GLASSvent® UT Window Details (4-side Captured Only) Steel Reinforcing and Anchor Details

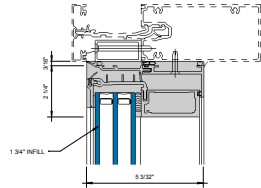

① HEAD PO. - 1-3/4" INFILL
6" = 1'-0"

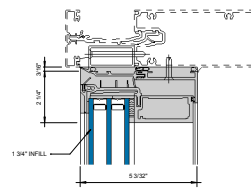

② HEAD COS. - 1-3/4" INFILL
6" = 1'-0"

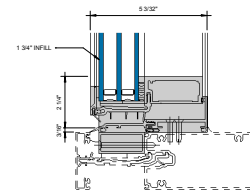

③ SILL POS. COS. - 1-3/4" INFILL
6" = 1'-0"

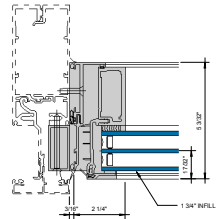

④ LEFT JAMB PO. - 1-3/4" INFILL
6" = 1'-0"

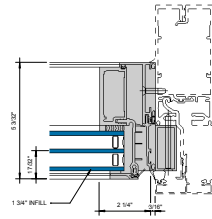

⑤ RIGHT JAMB PO. - 1-3/4" INFILL
6" = 1'-0"

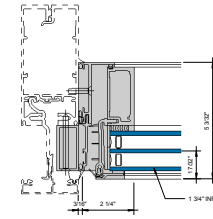

⑥ LEFT JAMB COS. - 1-3/4" INFILL
6" = 1'-0"

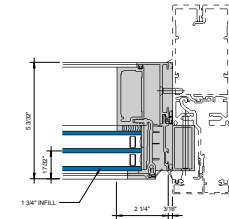

⑦ RIGHT JAMB COS. - 1-3/4" INFILL
6" = 1'-0"

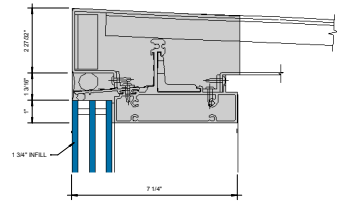

① SGT HEAD - 1-3/4" INFILL
6" = 1'-0"

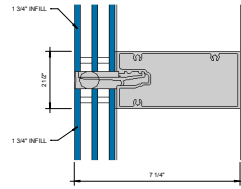

② SGT HORIZONTAL - 1-3/4" INFILL
6" = 1'-0"

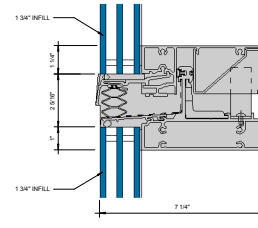

③ SGT EXPANSION HORIZONTAL - 1-3/4" INFILL
6" = 1'-0"

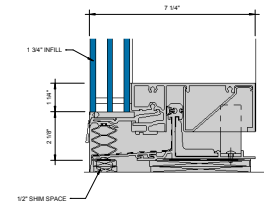

④ SILL - 1-3/4" INFILL
6" = 1'-0"

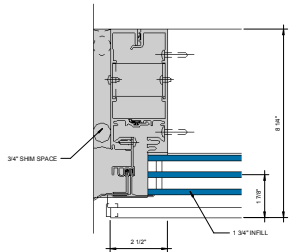

⑤ SGT JAMB - 1-3/4" INFILL
6" = 1'-0"

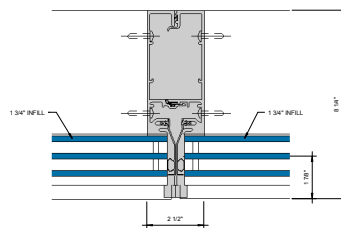

⑥ SGT VERTICAL MULLION - 1-3/4" INFILL
6" = 1'-0"

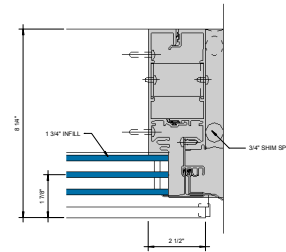

⑦ SGT JAMB - 1-3/4" INFILL
6" = 1'-0"

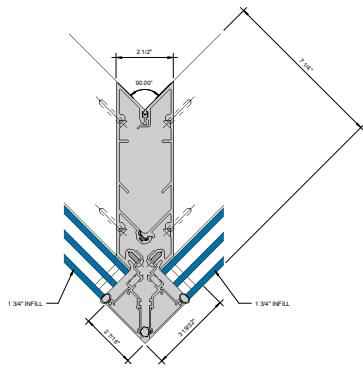

⑧ SGT 90° OUTSIDE CORNER - 1-3/4" INFILL
6" = 1'-0"

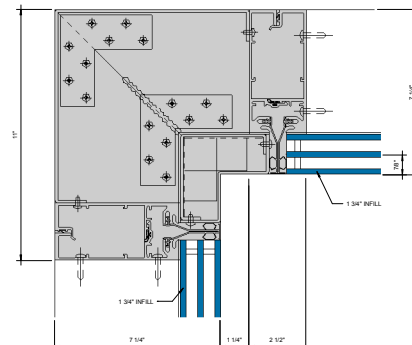

⑨ SGT 90° INSIDE CORNER - 1-3/4" INFILL
6" = 1'-0"

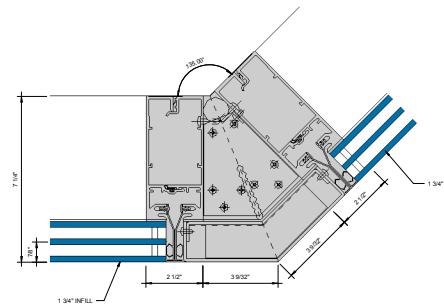

⑩ SGT 135° OUTSIDE CORNER - 1-3/4" INFILL
6" = 1'-0"

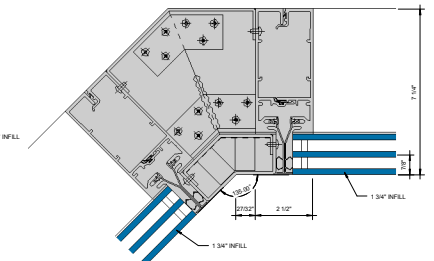

⑪ SGT 135° INSIDE CORNER - 1-3/4" INFILL
6" = 1'-0"

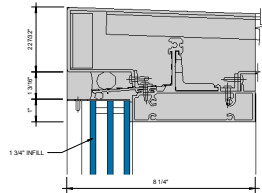

① HEAD - 1-3/4" INFILL
6" = 1'-0"

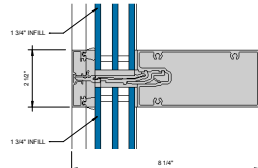

② HORIZONTAL - 1-3/4" INFILL
6" = 1'-0"

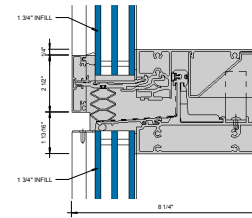

③ EXPANSION HORIZONTAL - 1-3/4" INFILL
6" = 1'-0"

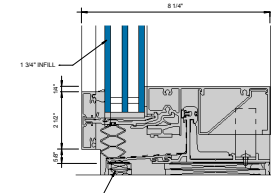

④ SILL - 1-3/4" INFILL
6" = 1'-0"

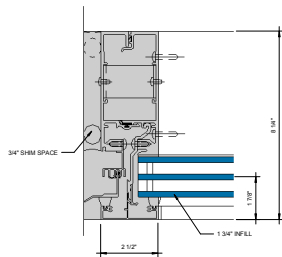

⑤ JAMB - 1-3/4" INFILL
6" = 1'-0"

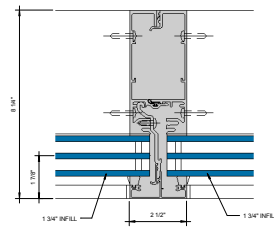

⑥ VERTICAL MULLION - 1-3/4" INFILL
6" = 1'-0"

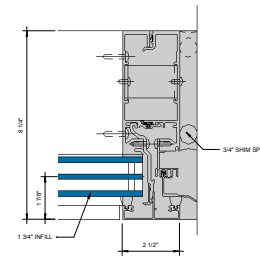

⑦ JAMB - 1-3/4" INFILL
6" = 1'-0"

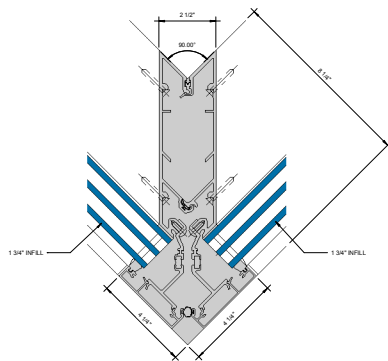

⑧ 90° OUTSIDE CORNER - 1-3/4" INFILL
6" = 1'-0"

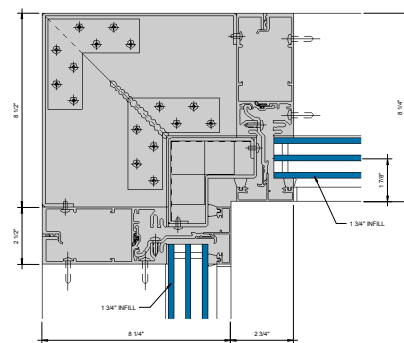

⑨ 90° INSIDE CORNER - 1-3/4" INFILL
6" = 1'-0"

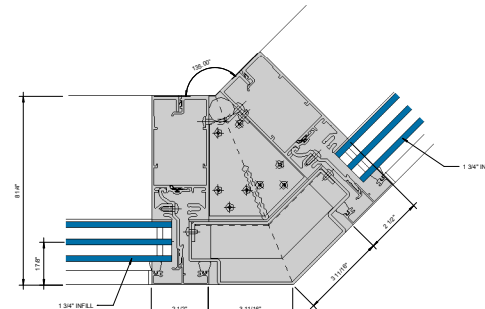

⑩ 135° OUTSIDE CORNER - 1-3/4" INFILL
6" = 1'-0"

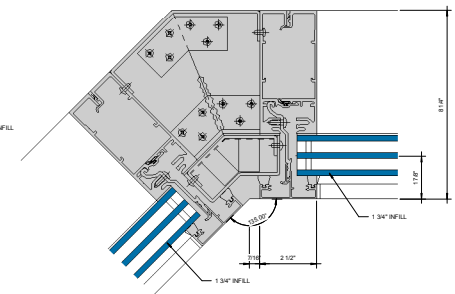

⑪ 135° INSIDE CORNER - 1-3/4" INFILL
6" = 1'-0"

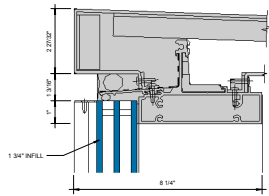

① SGT HEAD - 1-3/4" INFILL
6" = 1'-0"

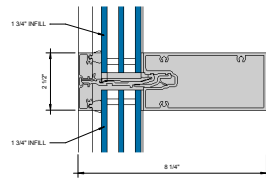

② HORIZONTAL - 1-3/4" INFILL
6" = 1'-0"

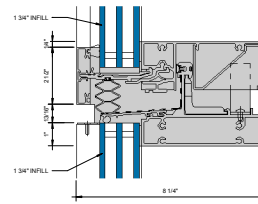

③ EXPANSION HORIZONTAL - 1-3/4" INFILL
6" = 1'-0"

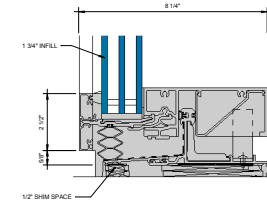

④ SILL - 1-3/4" INFILL
6" = 1'-0"

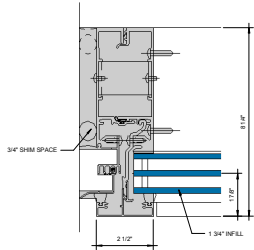

⑤ SGT JAMB - 1-3/4" INFILL
6" = 1'-0"

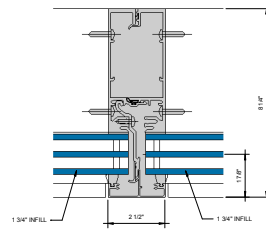

⑥ SGT VERTICAL MULLION - 1-3/4" INFILL
6" = 1'-0"

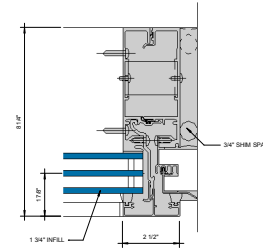

⑦ SGT JAMB - 1-3/4" INFILL
6" = 1'-0"

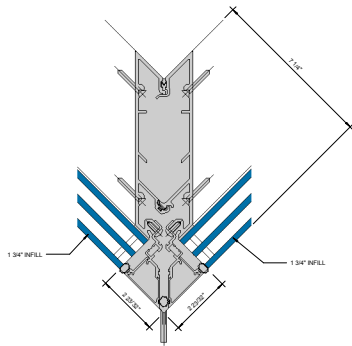

⑧ 90° OUTSIDE CORNER - 1-3/4" INFILL
6" = 1'-0"

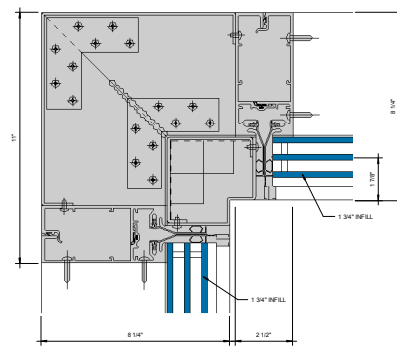

⑨ 90° INSIDE CORNER - 1-3/4" INFILL
6" = 1'-0"

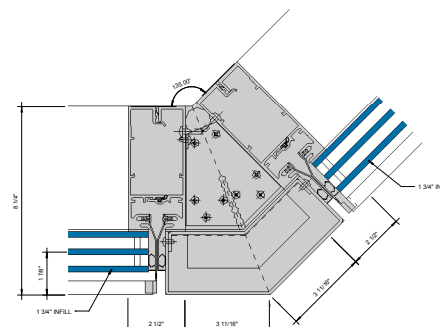

⑩ 135° OUTSIDE CORNER - 1-3/4" INFILL
6" = 1'-0"

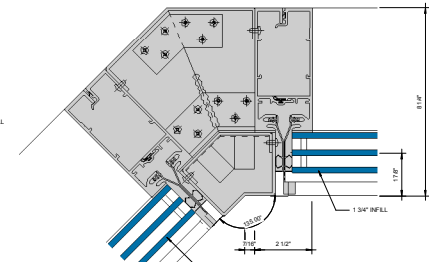

⑪ 135° INSIDE CORNER - 1-3/4" INFILL
6" = 1'-0"

Kawneer

2500 UT UNITWALL® SYSTEM 7-1/2" Deep SSG / 8-1/4" Deep Captured (1-3/4" infill)- GLASSvent® UT Window Details (4-side Captured Only)

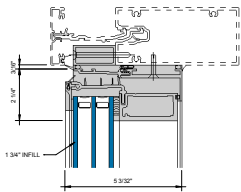

① HEAD PO - 1-3/4" INFILL
6" = 1'-0"

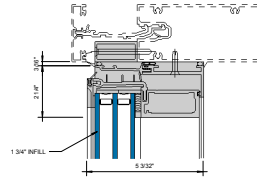

② HEAD COS - 1-3/4" INFILL
6" = 1'-0"

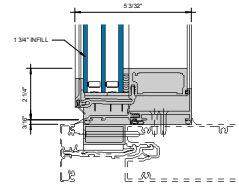

③ SILL - 1-3/4" INFILL
6" = 1'-0"

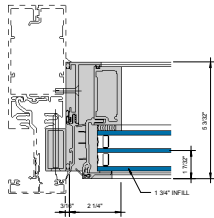

④ LEFT JAMB PO - 1-3/4" INFILL
6" = 1'-0"

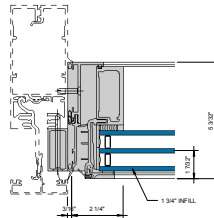

⑤ LEFT JAMB COS - 1-3/4" INFILL
6" = 1'-0"

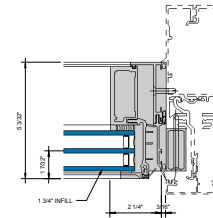

⑥ RIGHT JAMB PO - 1-3/4" INFILL
6" = 1'-0"

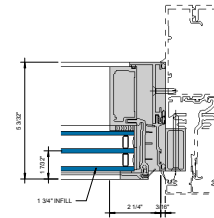

⑦ RIGHT JAMB COS - 1-3/4" INFILL
6" = 1'-0"

KAWNEER AN ARCONIC COMPANY

555 Guthridge Ct.
Technology Park/Atlanta
Norcross, GA 30092 USA
Tel: +1 770 449 5555

KAWNEER
AN ARCONIC COMPANY